

Scope it Out!

Maximizing the Effectiveness of Precipitator Inspections

By Jack Dumbauld and Tom Lugar, MET Buell APC

Much has been documented about the benefits of conducting both a dirty and clean internal precipitator inspection. In addition to these physical inspections, another important diagnostic tool that should be a key component of the inspection is the documenting and evaluating of the electrical characteristics of the precipitator. When this is done, it is usually in the form of observing/recording transformer-rectifier (TR) electrical readings during air-load energization of the ESP. This is conducted after inspection and maintenance work, just prior to ‘buttoning up’ before coming back on line. This serves as an insurance policy to check that there are no missed close electrical clearances or dead shorts caused by debris or tools left inside.

However, some detrimental conditions of the precipitator do not manifest themselves until the ESP is operating in flue gas conditions and components have expanded as operating temperature is reached and normal sparking conditions prevail. Thus, the electrical characterization of the precipitator should also be conducted just prior to the unit coming off line and would include the recording of TR electrical readings, noting secondary voltages at sparking, spark rates, and the generating of voltage-current characteristic curves (VI curves). This data can provide quite a bit of information about precipitator operation and condition. In addition, observing the electrical characteristics of each TR with an oscilloscope with storage capability, can provide an added dimension of analysis as a diagnostic tool.

An oscilloscope ‘EKG’ of each TR can pinpoint problems in the precipitator requiring a more thorough inspection of specific areas after unit shutdown. Some existing problems adversely affecting ESP performance and/or reliability may go undetected without the use of the oscilloscope as a diagnostic tool. With an oscilloscope, the location of spark initiation on the secondary current waveform can be determined as well as an evaluation of spark detection, response and recovery of the voltage controllers. With the precipitator on line, and observing electrical characteristics with an oscilloscope, one can also determine if performance problems are related to ash characteristics, internal mechanical/electrical conditions within the precipitator, response of the voltage controllers or a combination of the above.

The following are just some of the examples of the oscilloscope as a precipitator diagnostic tool.

Whipping wires or Swinging Grid

One important but not widely recognized problem with weighted-wire precipitators is whipping wires caused by inadequate wire tension due to bottle weights resting on the alignment grid rather than hanging free. This often occurs after a wire change-out because one or more new wires may be longer than the rest. Another cause of this problem is not enough clearance between the top of the post style anti-sway insulator and the wire alignment grid system. The anti-sway insulator may also have broken allowing the alignment grid to sway.

Like the strength of a chain, the amount of power input to an electrical section could be limited by just one rogue slack wire. You may not know that you have a whipping wire causing observed low power level sparking since this condition will only occur when the emitting wire lengthens at precipitator operating temperatures. How does one determine that there is a wire whipping or grid swaying in an ESP electrical section? Referring to the oscillogram of the secondary current waveform in Figure 1, sparks normally occur near the peak or just off the peak of the secondary current waveform.

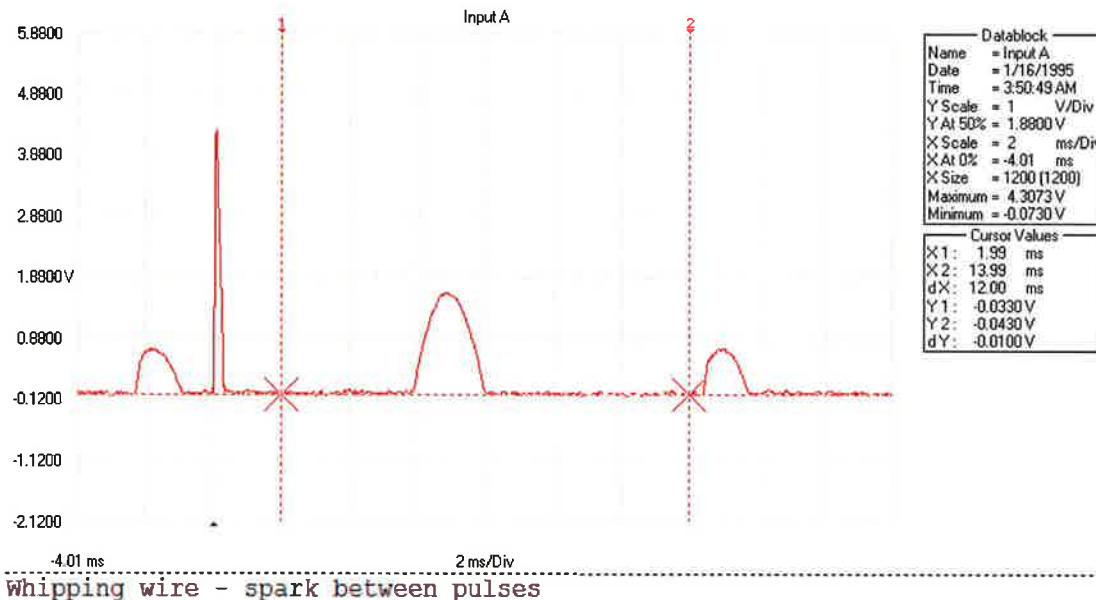

Figure 1

When a spark occurs between the secondary current pulses, it is highly likely that the cause is a high voltage component moving. For this situation, the spark occurs randomly and is not dependent on the applied precipitator voltage or power level.

Figure 2 shows one cause of a slack wire. The alignment grid ring is just below and very close to the bottle weight rivet. When operating temperature is reached, the wire will lengthen and hang up on the ring, eliminating wire tension.



Alignment ring should be below the rivet pin to account for wire lengthening when on-line.

Figure 2

Ringling Sparks

A spark should be observed as a narrow spike whenever it occurs. The oscillogram, Figure 3, shows many oscillations of a spark instead of a single spike on the secondary current waveform. These oscillations can cause spark response instability with the voltage controllers. At the installation that this oscillogram was recorded, the problem has been present for quite some time. Filtering circuits were added in an attempt to mitigate the problem when the controls were upgraded but had little effect on correcting the problem.

This problem is caused by the full wave connection of older, double outlet bushing, TRs being made by a switch located before the high voltage choke coils rather than after, as is the case with modern TRs, Figure 4. To demonstrate the fix for this problem, the 5-position high voltage switch was placed on Position #4, double half-wave mode of

operation. This opened the full wave switch connection before the choke coils, Figure 5. An external jumper was placed across the high voltage output bushings to establish full wave operation. Figure 6 oscillogram shows the elimination of spark ringing after the TR was re-energized.

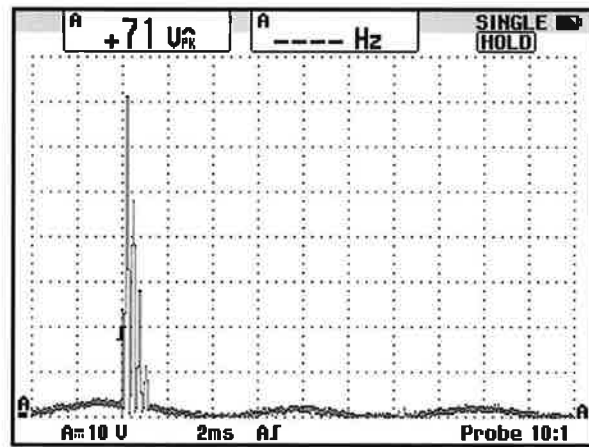

Ringing Sparks

Figure 3

Existing Configuration

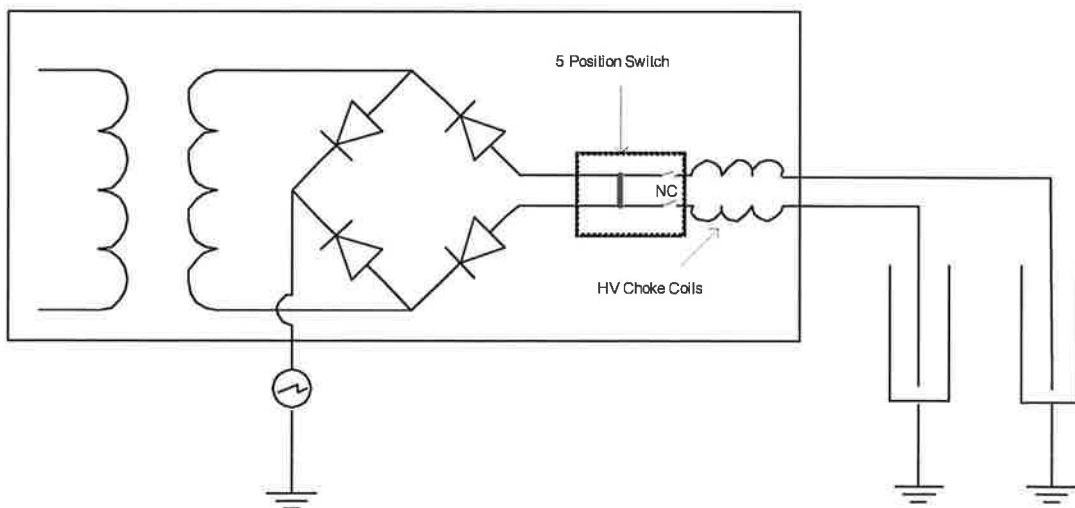

Figure 4

Position #4 with jumper
between HV output bushings

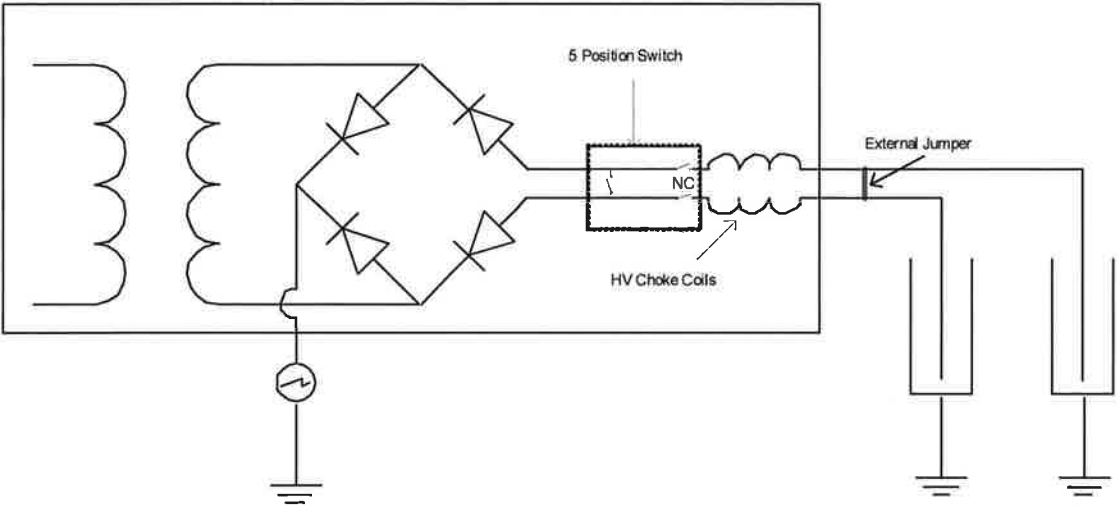
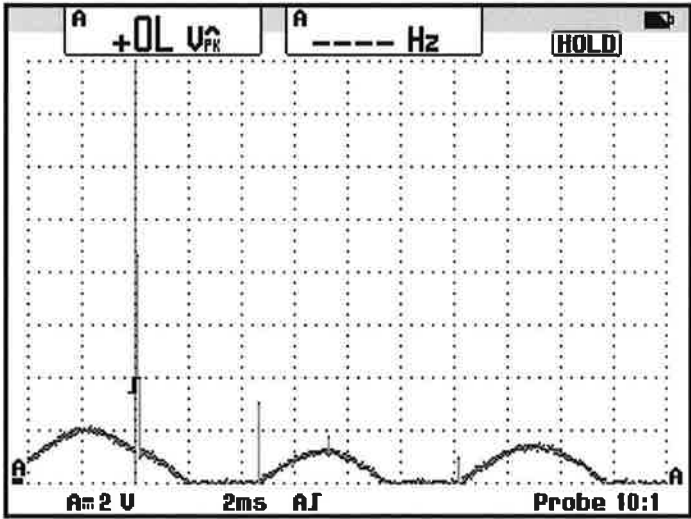

Figure 5



Ringling Sparks Eliminated

Figure 6

Voltage Controller Spark Response

Use of an oscilloscope is required to evaluate the TR voltage controllers to determine that they are properly detecting and responding to sparking. This evaluation is best done with the unit on-line under flue gas conditions with the resulting spark conditions prevailing. Under air-load energization, some electrical fields may exhibit little or no sparking. Some examples of common control problems are shown in Figure 7 through 10 oscillograms.

Figure 7's oscillogram shows a controller not detecting sparks. The power level is increasing, causing multiple sparking. Figure 8 shows a typical controller spark response to a high energy spark. Note that spark detection and response will vary depending on the controller manufacturer's philosophy of spark response and the settings chosen.

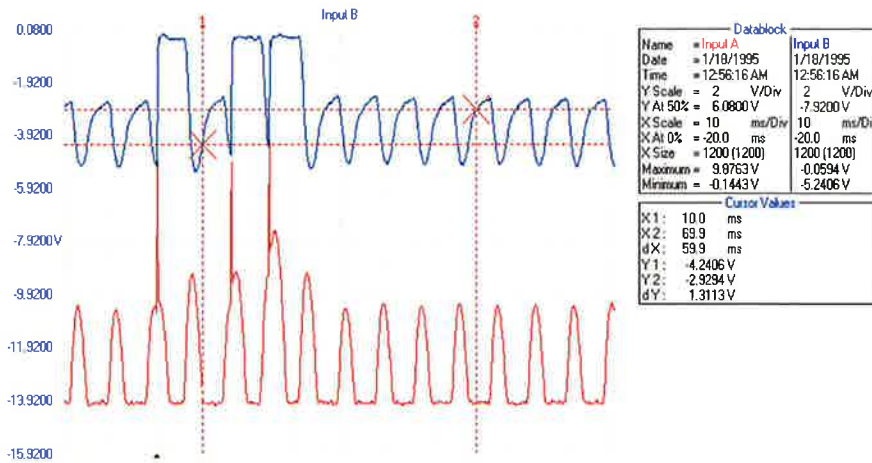

Missed Sparks
Figure 7

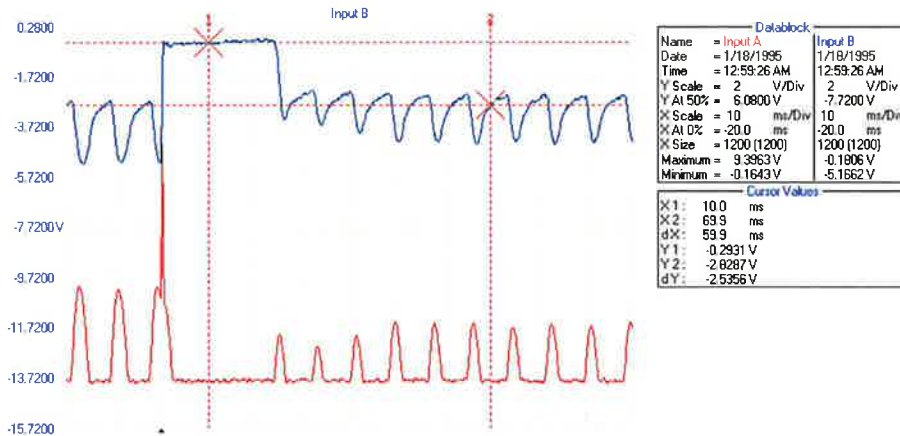

Typical Spark response
Figure 8

Figure 9 shows an excessively long, 74 millisecond, off-time response after a spark is detected. The magnitude of the reduction in average power input to the affected electrical field(s) will depend on the sparking rate.

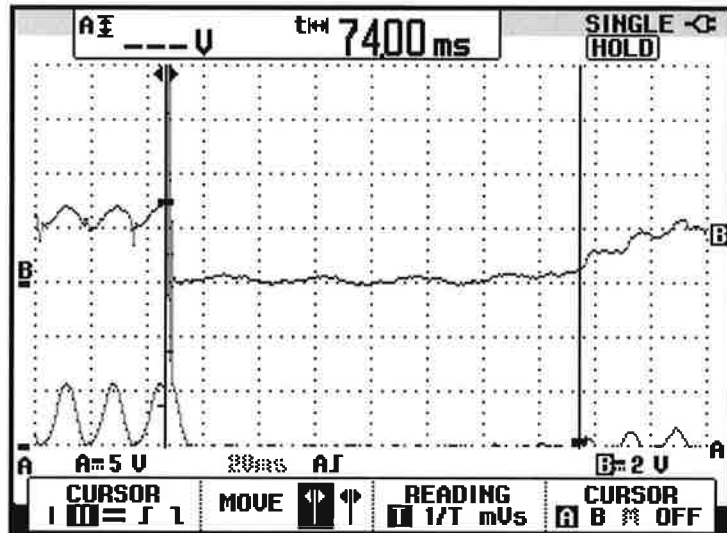

Excessive Off-time after Spark Detection

Figure 9

Figure 10's oscillogram shows an example of loss of control. Upon detection of a spark, the controller should immediately turn off or reduce power, depending on the spark intensity, to reduce the potential of multiple sparking or burst sparking occurring. In this example, a burst of sparks is not detected and the controller actually raises the amplitude of the next half cycle of secondary current which results in a large amplitude arc.

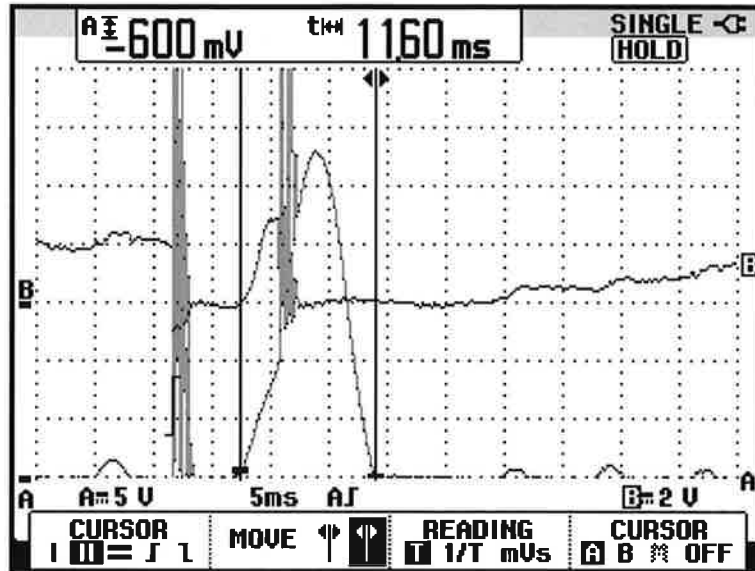

Loss of Control

Figure 10

Back Corona Detection

In many cases the useful operating current density in the precipitator is limited by the resistivity (electrical conductivity) of the ash layer on the plates. If the ash resistivity is sufficiently high, electrical breakdown of the ash layer will occur at a precipitator voltage level below sparking. Glow points of corona will form on the ash layer surface generating ions of opposite polarity to those produced by corona emission from the emitting electrodes. Thus the term back corona and also referred to as back ionization. Back corona positive ions are attracted to the negative polarity emitting electrodes and will neutralize negative ions for particulate charging and disrupt the space charge that stabilizes the corona formed on the emitting electrodes. The resulting performance of the precipitator will be reduced to an extent dependent upon the severity of the back corona condition.

Back corona electrical characteristics can easily be observed with an oscilloscope and also with VI curves. As precipitator voltage and current rise with increasing power applied, a point is reached where the secondary voltage (KV) does not increase further or reduces as secondary current (MA) continues to increase. Figure 11's oscillogram shows the secondary voltage rising but then dropping as current continues to increase. Figure 12 shows a classic decay in the trough of the KV waveform with increasing current indicating back corona.

Scope Trace Showing Back Corona

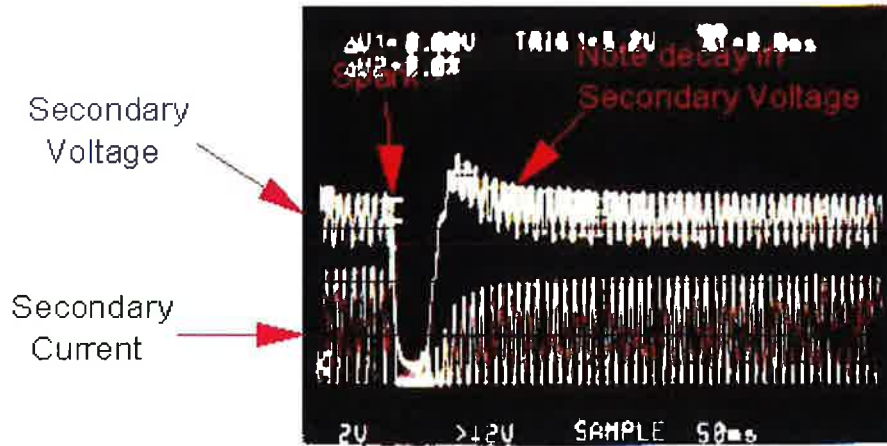

Courtesy of Russ Ridgeway, AEP
Figure 11

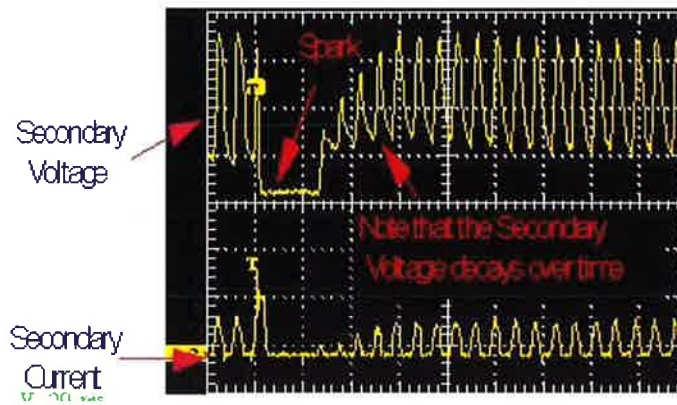

Courtesy of Russ Ridgeway, AEP
Figure 12

In conclusion, the examples presented have shown that the oscilloscope can be an integral tool in conducting a more thorough inspection of the precipitator. In fact, these problems may not be identified at all without the use of the oscilloscope. So, for your next scheduled precipitator inspection, scope it out!